

YATES "YS" SERIES ROUND BODY CYLINDERS

YS-2500 SERIES SUITABLE FOR AIR OR MEDIUM DUTY HYDRAULIC SERVICE.

- Ductile iron head and piston are made from fine grained centrifugally cast bar stock.
- O-ring boss ports supplied standard, NPTF available at no extra charge.
- Piston rod is ground, polished and chrome plated medium carbon steel.
- Polypak piston seals with glass-filled nylon bearing is standard.
Viton or Teflon piston seals are optional.
- Polypak rod seal with a Urethane rod wiper are standard.
High temperature rod seals are optional.
- Head gland retained with internal retaining ring is standard on medium duty.

YS-3000 SERIES FOR HEAVY DUTY USE IN HIGH PRESSURE APPLICATIONS.

- Ductile iron head and piston are made from fine grained centrifugally cast bar stock.
- O-ring boss ports supplied standard, NPTF available at no extra charge.
- Piston rod is ground, polished and chrome plated steel.
- Polypak piston seals with glass-filled nylon bearing is standard.
Viton or Teflon piston seals are optional.
- Polypak rod seal with a Urethane rod wiper are standard.
High temperature rod seals are optional.

YATES "YS" SERIES ROUND BODY CYLINDERS

CUSTOM BUILT CYLINDER APPLICATION

ROD END
VIEW COLUMN

BASE END
VIEW COLUMN

NAME: _____

SINGLE OR DOUBLE ACTING: _____ BORE DIA.: _____ ROD DIA.: _____

SYSTEM OPERATING PRESSURE: _____ FLUID TYPE: _____

"A" RETRACTED LEN: _____ "B" STROKE: _____ "C" TUBE O.D.: _____

"E" ROD MOUNT: _____ "F" ROD PIN DIA.: _____ "G" ROD EXTENSION: _____

"H" BASE MOUNT: _____ "I" BASE PIN DIA.: _____ "J" MOUNT: _____

COMMENTS: _____

PORTS TYPE: _____ RETRACT SIZE: _____ EXTENDED SIZE: _____

QUOTE QTY: _____

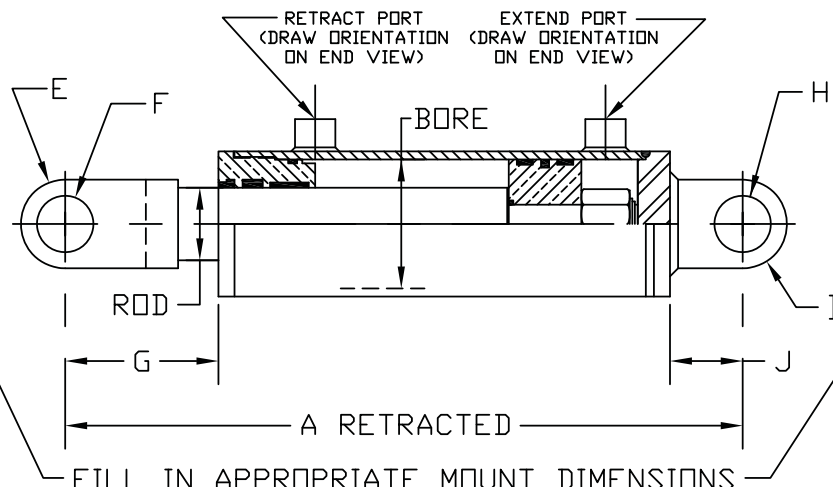
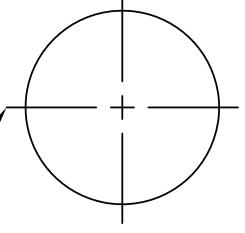
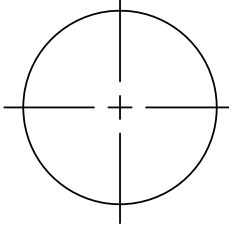
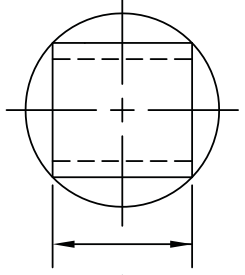
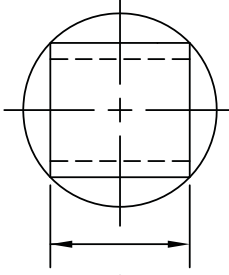
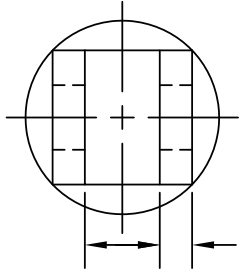
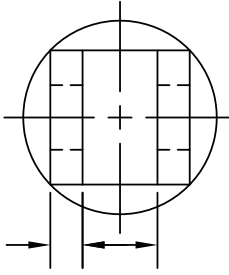

DRAW SPECIAL
MOUNT

DRAW SPECIAL
MOUNT

